

YEARS: 2020-PRESENT

MAKE: HYUNDAI

MODEL: PALISADE

STYLE: SUV

WARNING: NEVER EXCEED YOUR VEHICLE MANUFACTURER'S RECOMMENDED TOWING CAPACITY
 For more information log onto www.curtmfg.com & for helpful towing tips log onto www.hitchinfo.com

WEIGHT CARRYING:
 TRAILER WEIGHT: 5,000 LBS.
 TONGUE WEIGHT: 750 LBS.

WEIGHT DISTRIBUTION:
 TRAILER WEIGHT: 6,000 LBS.
 TONGUE WEIGHT: 750 LBS.

PRO INSTALL TIME: 45 MIN.
NOVICE INSTALL TIME: 90 MIN.

IF YOU ARE HESITANT TO UNDERTAKE THIS TASK ON YOUR OWN, CONTACT AN AUTHORIZED CURT INSTALLER FOR ADDITIONAL ASSISTANCE.

INSTALLATION REQUIRES:

RATCHET	TORQUE WRENCH	6" SOCKET EXTENSION
11mm 14mm 17mm 19mm SOCKET	SCREW DRIVER	BOXED END WRENCH 19mm
SAFETY GLASSES		

INSTALLATION TIPS:

- BEFORE YOU BEGIN INSTALLATION, READ ALL INSTRUCTIONS THOROUGHLY.
- TO EASE INSTALLATION, 2 PEOPLE MAY BE REQUIRED.
- USING PROPER TOOLS WILL GREATLY IMPROVE THE QUALITY OF THE INSTALL AND REDUCE THE TIME REQUIRED.
- NEED HELP OR HAVE SOME QUESTIONS? CALL TECHNICAL SUPPORT AT 877.287.8634

LEVEL OF DIFFICULTY: MODERATE

EASY	MODERATE	CHALLENGING
	NO DRILLING REQUIRED	
	LOWER EXHAUST	
	LOWER SPARE TIRE	
	TEMPORARILY REMOVE UNDERBODY PANEL	

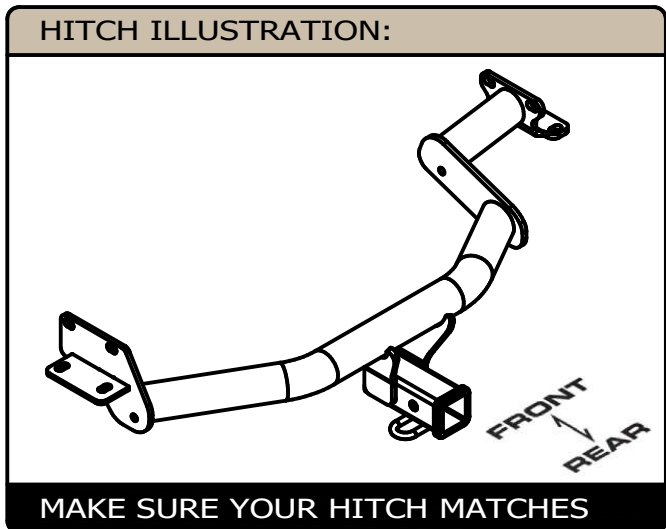

PERIODICALLY CHECK THIS RECEIVER HITCH TO ENSURE ALL FASTENERS ARE TIGHT AND ALL STRUCTURAL COMPONENTS ARE SOUND
 CURT Manufacturing LLC. warrants this product to be free of defects in material and/or workmanship at the time of retail purchase by the original purchaser. If the product is found to be defective, CURT Manufacturing LLC. may repair or replace the product at their option, when the product is returned, prepaid, with proof of purchase. Alteration to, misuse of, or improper installation of this product voids the warranty. CURT Manufacturing LLC.'s liability is limited to repair or replacement of products found to be defective, and specifically excludes liability for incidental or consequential loss or damage.
 For more information log onto www.curtmfg.com
 This product complies with safety specifications and requirements for connecting devices and towing systems of the state of New York, V.E.S.C.Regulation V-5 and SAE J684.

INSTALLATION WALKTHROUGH:

Parts List			
ITEM	QTY	PART NUMBER	DESCRIPTION
1	4	10-10271	HHCS,M10x1.25,30,CL10.9,YZ
2	4	10-10283	HHCS,M12x1.75,120,CL10.9,YZ
3	4	20-00136	NUT, HEX,M12x1.75,CL10,YZ
4	8	30-00149	WASHER, S-CON,1/2,YZ
5	4	30-00163	WASHER,S-CON,7/16,YZ

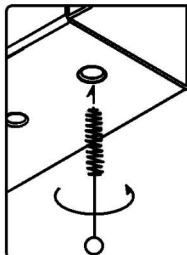
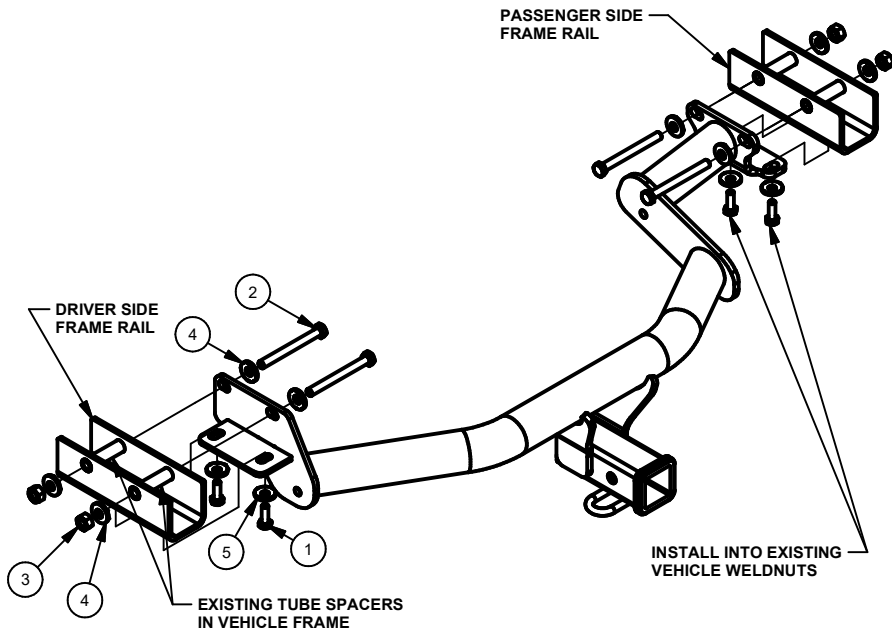

WELDNUT CLEANING

To remove debris from weldnuts in frame, spray lubricant or compressed air into hole. For heavy debris, use a small wire brush. (Be careful not to damage threads).

FRONT
↕
REAR

1. Lower spare tire with 11mm socket and ratchet. Place spare off to the side.



2. Remove the driver side underbody panel by removing (3) push clips and turning (2) plastic retainers counterclockwise with a 14mm socket.



INSTALLATION WALKTHROUGH:

3. Unhook the (4) rearward most exhaust isolators to lower the exhaust. NOTE: be sure to support exhaust.



4. Raise hitch into position over exhaust and loosely install fasteners as shown on page 2.

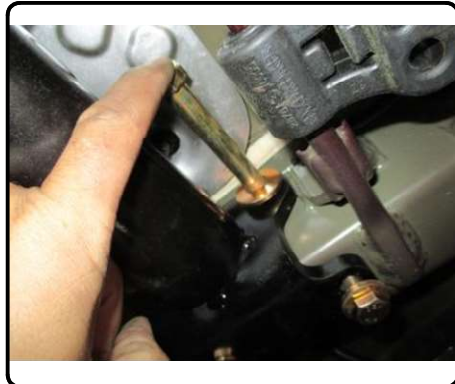
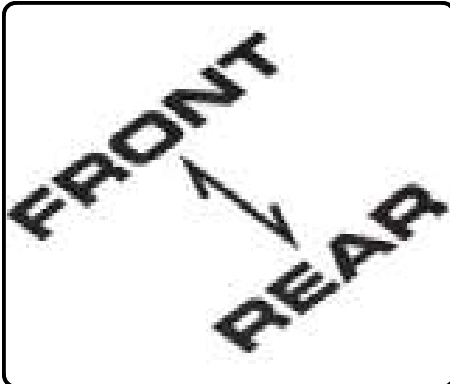

5. Torque all 12mm fasteners to 79 lb-ft and all 10mm fasteners to 48 lb-ft.
6. Reinstall underbody panel, raise spare tire back into position and reinstall the exhaust isolators.

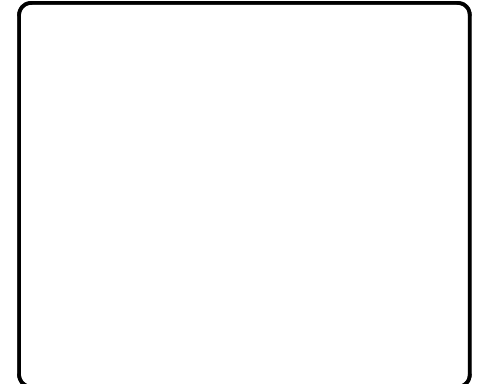
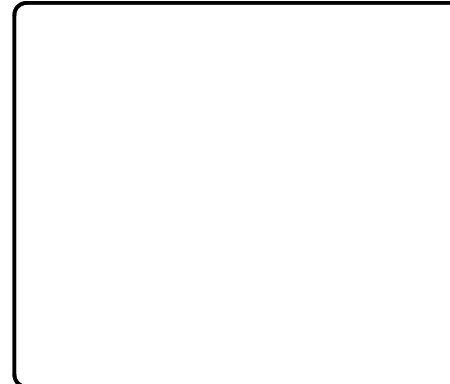

TOWING SAFETY INFORMATION

Gross Trailer Weight / GTW

The Gross Trailer Weight is the weight of the trailer & cargo. Measure this by putting the fully loaded trailer on a vehicle scale.

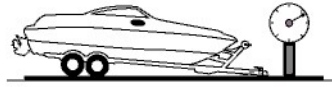

Tongue Weight / TW

The downward force that is exerted on the hitch ball by the coupler. The tongue weight will vary depending on where the load is positioned in relationship to the trailer axle(s). To measure the tongue weight, use either a commercial scale or a bathroom scale with the coupler at towing height. When using a bathroom scale with heavier tongue weights, use the method shown and multiply the scale reading by 3.

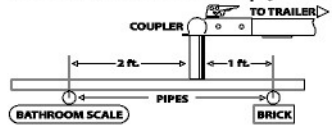

Weight Carrying / WC

The total weight of both the trailer and the cargo inside. Never exceed the weight capacity of your trailer hitch.

Weight Distribution / WD

Used to balance the weight of the cargo between the front and rear wheels throughout the trailer, allowing for better steering, braking, and level riding.



Sway Control

A device used to reduce the lateral movements of the trailer that are caused by the wind. This works in conjunction with a weight distribution hitch. Do not use this on a class 1 or 2 hitch, or with surge brakes.

How Much Can You Safely Tow?

TONGUE WEIGHT (lb)	1000	2000	3000	4000	5000	6000	7000	8000	10,000	12,000	
Tongue weight should be about 10 to 15 percent of the gross trailer weight.											
TRAILER TYPE	CLASS 1		CLASS 2			CLASS 3			CLASS 4		CLASS 5
Camper	11'	12'	13'	14'	15'	16'					
lbs.	1100	1200	1300	1400	1500	1600					
Vacation	18'	18'	18'	20'	22'	24'	26'	28'	30'	32'	
lbs.	2100	2400	2700	3000	3300	3600	3900	4200	4500	4800	
Vacation	18'	18'	18'	20'	22'	24'	26'	28'	30'	32'	
lbs.	2800	3200	3600	4000	4400	4800	5200	5600	6000	6400	
5th Wheel											

Refer to owner's manual for towing capabilities and limitations.

Ball Mount

The ball mount is placed inside the opening of the receiver hitch which is mounted to the vehicle. Make sure a hitch pin and clip is properly securing the ball mount to the receiver hitch before you begin towing.

- A: Rise. B: Drop. C: Hole Size. D: Length.

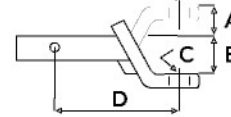

Trailer Ball

The connection from the hitch to the trailer. There are many factors that determine the correct hitch ball:

- Number one is the hitch ball's gross trailer weight rating.
- The mounting platform must be at least 3/8" thick.
- The hole diameter must not be more than 1/16" larger than the threaded shank.
- Every time you tow, check the nut and lock washer to make sure they are fastened securely.
- A: Ball Dia. B: Shank Length. C: Shank Dia. D: Shank Rise.

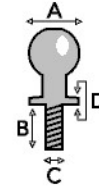

Coupler

The component that is placed over the trailer ball to connect the vehicle to the trailer. Be sure that the coupler size matches the size of the hitch ball and that the coupler handle is securely fastened. To determine what size hitch ball you need for your application you will need to know the size of coupler that is on the trailer. Be sure your coupler is properly adjusted to the ball you are using.

NOTE: For added security the use of safety devices such as Coupler Safety Pins and Locks is strongly recommended.

Safety Chains

Safety chains are a requirement and should be crossed under the tongue of the trailer so that the tongue will not drop to the road if it becomes separated from the hitch. Always leave enough slack so you can turn. Never allow the safety chains to drag on the ground and never attach the chains to the bumper.

Trailer Classification: Safety Chain Breaking Force - Minimum

Class 1: 2,000 lbs. (8.9 kN)

Class 2: 3,500 lbs. (15.6 kN)

Class 3: 5,000 lbs. (22.2 kN)

The strength rating of each length of safety chain or its equivalent and its attachments shall be equal to or exceed in minimum breaking force the GVWR (Gross Vehicle Weight Rating) of the trailer.

Electrical

Trailer lights, Electric Brakes, Break-away systems - Every time you tow, be sure to check that all components are working properly.

Wiring identification by color:

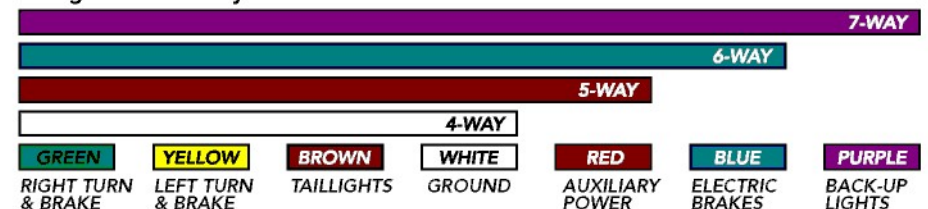

CURT DISCLAIMER: WIRING COLOR SHOWN WORK IN CONJUNCTION WITH CURT MANUFACTURING PRODUCTS.

13427

HYUNDAI PALISADE

07/06/2020

GROSS LOAD CAPACITY WHEN USED AS A WEIGHT CARRYING HITCH: 5,000 LBS. TRAILER WEIGHT & 750 LBS. TONGUE WEIGHT.
 GROSS LOAD CAPACITY WHEN USED AS A WEIGHT DISTRIBUTION HITCH: 6,000 LBS. TRAILER WEIGHT & 750 LBS. TONGUE WEIGHT.



WARNING: * DO NOT EXCEED VEHICLE MANUFACTURER'S RECOMMENDED TOWING CAPACITY. *****

FOR MORE INFORMATION LOG ONTO WWW.CURTMFG.COM
 HAVING INSTALLATION QUESTIONS? CALL TECHNICAL SUPPORT AT 1-877-287-8634



Parts List			
ITEM	QTY	PART NUMBER	DESCRIPTION
1	4	10-10271	HHCS,M10x1.25,30,CL10.9,YZ
2	4	10-10283	HHCS,M12x1.75,120,CL10.9,YZ
3	4	20-00136	NUT, HEX,M12x1.75,CL10,YZ
4	8	30-00149	WASHER, S-CON,1/2,YZ
5	4	30-00163	WASHER,S-CON,7/16,YZ

TOOLS REQUIRED
RATCHET
TORQUE WRENCH
6" SOCKET EXTENSION
11mm, 14mm, 17mm, 19mm SOCKETS
STRAIGHT SCREW DRIVER
19mm BOXED END WRENCH
SAFETY GLASSES

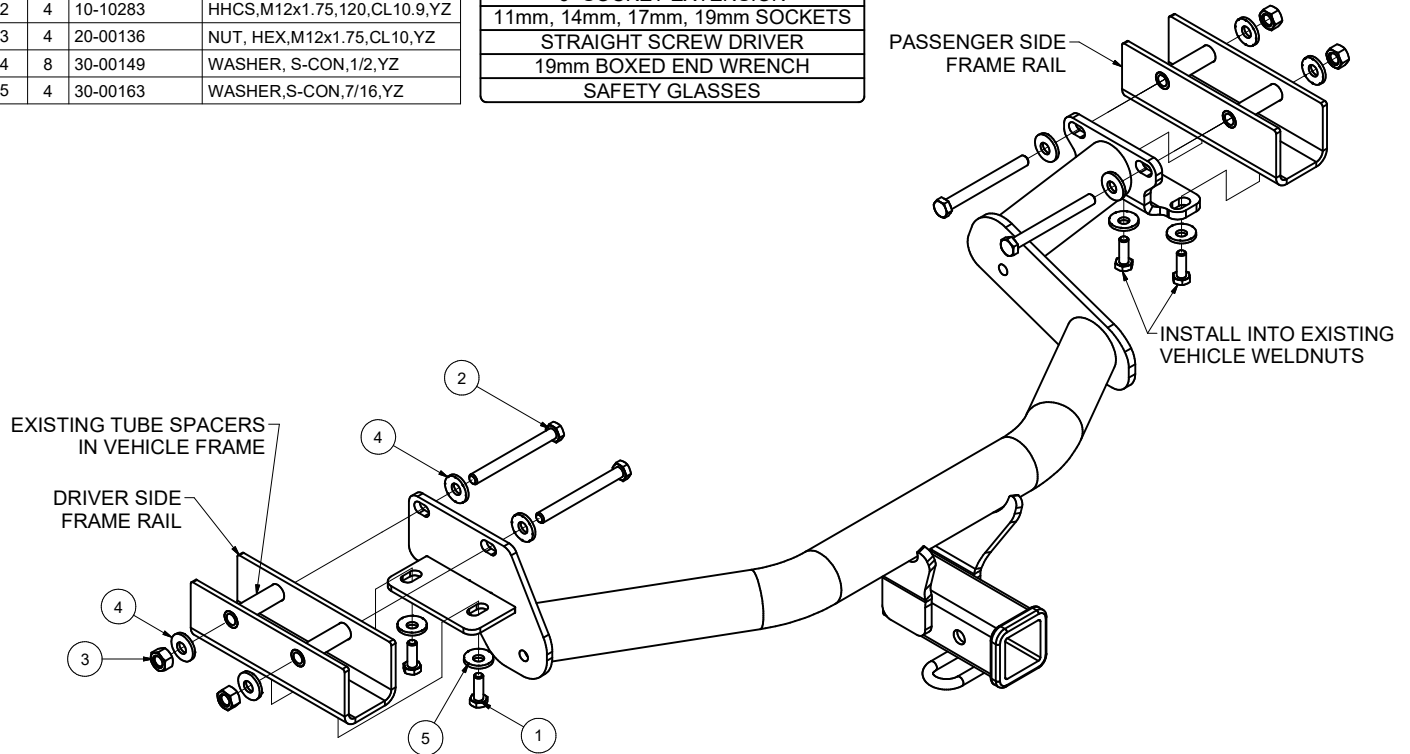

HITCH WEIGHT: 39 LBS.

INSTALL TIME

PROFESSIONAL: 45 MINUTES

NOVICE (DIY): 90 MINUTES

INSTALL NOTES:

- NO DRILLING REQUIRED
- LOWER EXHAUST
- TEMPORARILY REMOVE UNDERBODY PANEL

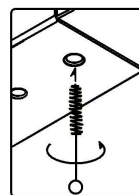

WELDNUT CLEANING

To remove debris from weldnuts in frame, spray lubricant or compressed air into hole. For heavy debris, use a small wire brush. (Be careful not to damage threads).

FRONT
REAR

INSTALLATION STEPS

1. Lower spare tire with 11mm socket and ratchet. Place spare off to the side.
2. Remove the driver side underbody panel by removing (3) push clips and turning (2) plastic retainers counterclockwise with a 14mm socket.
3. Unhook the (4) rearward most exhaust isolators to lower the exhaust. NOTE: be sure to support exhaust.
4. Raise hitch into position over exhaust and loosely install fasteners as shown above.
5. Torque all 12mm fasteners to 79 lb-ft and all 10mm fasteners to 48 lb-ft.
6. Reinstall underbody panel, raise spare tire back into position and reinstall the exhaust isolators.

PERIODICALLY CHECK THIS RECEIVER HITCH TO ENSURE THAT ALL FASTENERS ARE TIGHT AND THAT ALL STRUCTURAL COMPONENTS ARE SOUND.



Scan for more information

CURT Manufacturing LLC., warrants this product to be free of defects in material and/or workmanship at the time of retail purchase by the original purchaser. If the product is found to be defective, CURT Manufacturing LLC., may repair or replace the product, at their option, when the product is returned, prepaid, with proof of purchase. Alteration to, misuse of, or improper installation of this product voids the warranty. CURT Manufacturing LLC.'s liability is limited to repair or replacement of products found to be defective, and specifically excludes liability for incidental or consequential loss or damage.

This product complies with safety specifications and requirements for connecting devices and towing systems of the state of New York, V.E.S.C.Regulation V-5 and SAE J684.